

Double-Ended Cordsets
BCC M415-M414-3D-338-ES64N9-100
 Order Code: BCC0EY2

BALLUFF

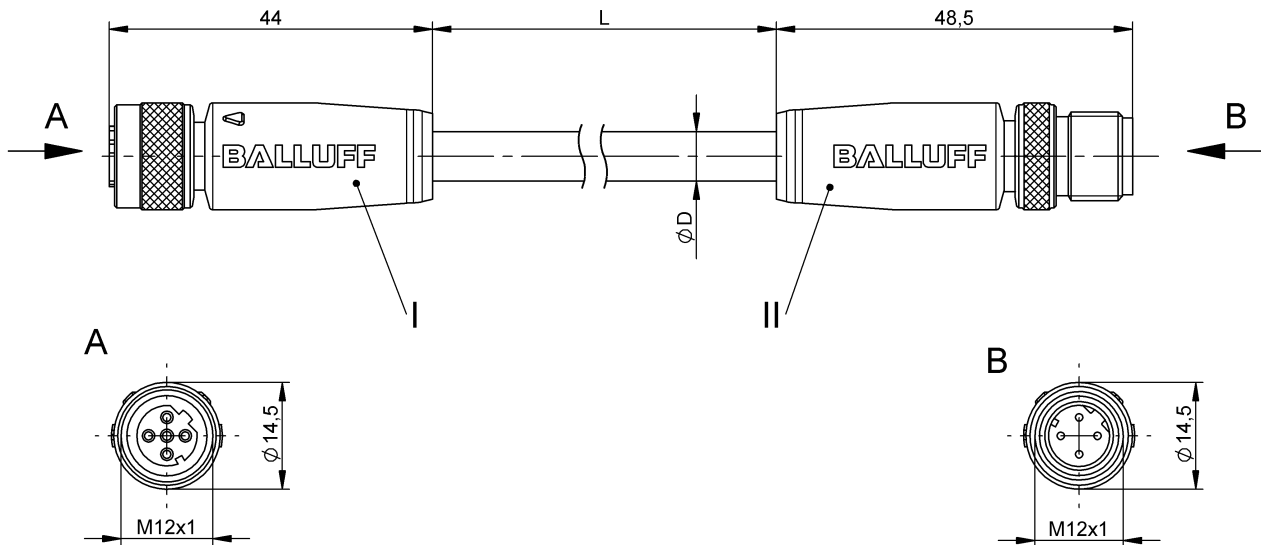

Basic features

Application	Ethernet, CAT 5
Approval/Conformity	CE cULus WEEE

Electrical connection

Bending radius min., flexible cable	10 x D
Cable	TPE Shielded teal, 10 m, drag chain compatible
Cable diameter D	6.10 mm ±0.25 mm
Cable, bending cycles min.	10 mil.
Cable, note	Ethernet, CAT 5E
Conductor cross-section	24 AWG
Connection 1	M12x1-Female, straight, 5-pin, D-coded
Connection 2	M12x1-Male, straight, 4-pin, D-coded
Number of conductors	4
System	Molded/Molded

Electrical data

Cable rated voltage AC max.	600 V
Cable rated voltage DC max.	600 V
Conductor construction	2x2 twisted-pair
Conductor resistance	≤ 26.0 Ohm/1000 ft
Coupling resistance max.	100 Ohm ±15 Ohm
Operating capacitance	13.5 pF/ft
Operating voltage Ub	60 VDC
Rated current (40 °C)	1.5 A
Transfer rate	10/100 Mbit/s

Environmental conditions

Cable temperature, flexible routing	-40...80 °C
IP rating	IP67/IP67

Material

Cable jacket material, note	Shielded
Cable jacket, material	TPE
Cable shield	Aluminum foil and copper braid
Material contact carrier	PUR/PUR
Material contacts	Bronze/Brass
Material cover nut	Brass nickel-plated/Brass nickel-plated
Material grip	PUR/PUR

Mechanical data

Cable jacket, color	teal
Cable length L	10.00 m
Cable properties	drag chain compatible
Tightening torque pigtail	0.6 Nm/0.6 Nm

Remarks

Cable construction acc. to UL CMX Outdoor or AWM Style 2463
Enclosure rating per IEC 60529, only in screwed state with the associated mating piece.
360° shield on cover nut

Connector Drawings

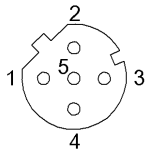

I

PIN 1: white/orange
PIN 2: white/green
PIN 3: orange
PIN 4: green
PIN 5: not used

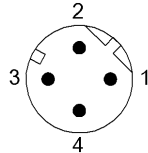

II

PIN 1: white/orange
PIN 2: white/green
PIN 3: orange
PIN 4: green

Wiring Diagrams

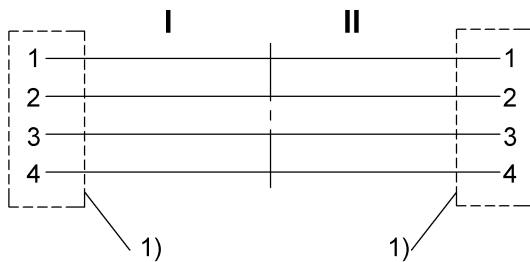

1) Shield on cover nut